

# Karbon 800 Product Manual

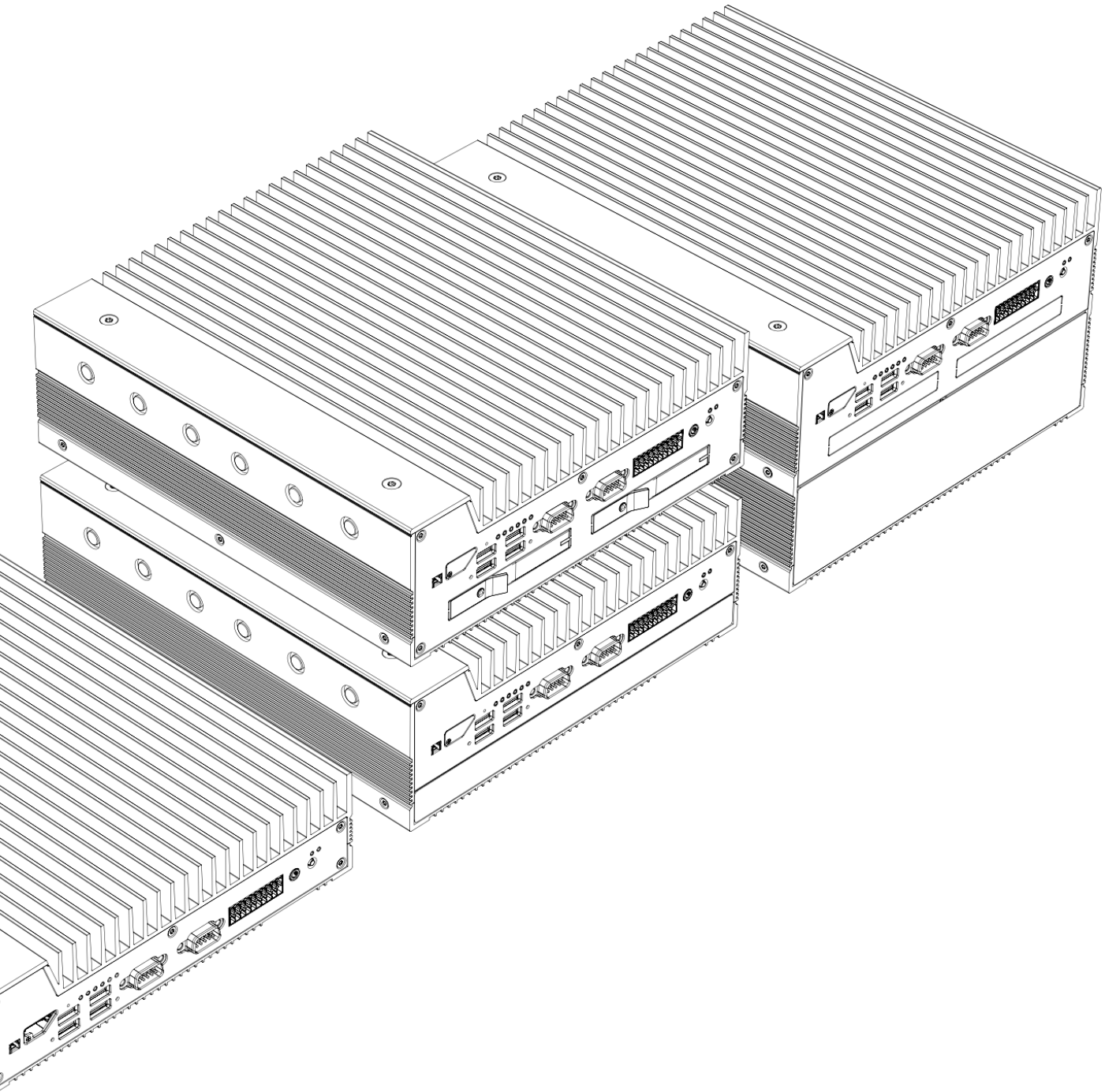

# Revision History

Date	Revision History
6/21/2022	First release of Karbon 800 manual

<b>1 - System Overview</b>	<b>5</b>
1.1 - Accessories	5
1.2 - Product Specifications	6
1.3 - Exterior Features & Dimensions	9
1.3.1 - Front I/O	9
1.3.2 - Back I/O	9
1.3.3 - K801 System Dimensions	10
1.3.4 - K802 System Dimensions	10
1.3.5 - K803 System Dimensions	11
1.3.6 - K804 System Dimensions	11
1.4 - Motherboard Overview	12
1.4.1 - System Block Diagram	12
1.4.2 - Motherboard Features	13
<b>2 - I/O Definitions</b>	<b>15</b>
2.1 - Serial Ports	15
2.2 - DIO, CAN, Ext. Power Switch	16
2.2.1 - DIO Connection Diagram	17
2.4 - Status LEDs	18
2.5 - Automotive Ignition Power Sensing (IGN)	19
2.7 - Networking	20
2.9 - DisplayPort	20
2.10 - SIM Cards	20
2.11 - RTC Reset Button	21
2.12 - Modbay Expansion	21
2.12.1 - Modbay 4x LAN Expansion	21
2.12.2 - Modbay 4x PoE Expansion	21
2.12.3 - Modbay 3x M12 LAN Expansion	21
2.12.4 - Modbay 3x M12 PoE Expansion	22
2.12.5 - Modbay 2x 10Gb LAN Expansion	22

2.12.6 - Modbay 4x USB3 Expansion	22
<b>3 - Motherboard Connectors</b>	<b>22</b>
3.1 - M.2 2280 M-key 1	22
3.2 - M.2 2280 M-key 2	23
3.3 - M.2 3042/3052/2280 B-key	23
3.4 - M.2 2230 E-key	23
3.5 - mPCIe	23
3.6 - TPM Header	23
3.7 - Onboard PoE Header	23
3.8 - Aux Power Expansion Header	24
3.9 - SATA Headers	24
3.10 - PCIe Gen 5.0 x16 Connector	24
3.10.1 - PCIe x16 Riser (K803)	24
3.10.2 - PCIe x16 Riser (K804)	24
3.10.3 - Dual PCIe x8 Riser (K804)	24
3.11 - DDR4 SO-DIMM Slots	25
<b>4 - Mounting Instructions</b>	<b>26</b>
4.1 - Wall Mount Brackets	26
4.2 - Wall Mount Brackets with Vibration Isolation	27
4.3 - DIN Rail Mount Brackets	28
<b>5 - OnLogic Microcontroller (MCU)</b>	<b>28</b>
5.1 - Overview	28
<b>6 - Power Management</b>	<b>29</b>
6.1 - Wake-Up Events	29
6.2 - Protection Circuitry	29
<b>7 - Regulatory Compliance</b>	<b>30</b>
7.1 - CE	30
7.2 - FCC Statement	30
7.3 - ISED	30

7.4 - UKCA	30
7.5 - VCCI	30
<b>8. Appendices</b>	<b>31</b>
8.1 - Appendix A: Software Documentation	31
8.2 - Appendix B: System Thermal Results	31
8.2.1 - Testing Conditions	31
8.2.2 - Results Summary	31
8.3 Appendix C: PoE Power Budget	33
8.4 - Appendix D: Expansion Port Pinouts	34
8.4.1 - M.2 B-key Pinout	34
8.4.2 - M.2 M-key Pinout	35
8.4.3 - M.2 E-key Pinout	35
8.4.4 - mPCIe Pinout	36
8.5 - Appendix D: Errata	37
8.6 - Appendix E: Safety Information	37
8.6.1 - Safe use and installation instructions	37
8.6.2 - Précautions et guide d'installation	39

# 1 - System Overview

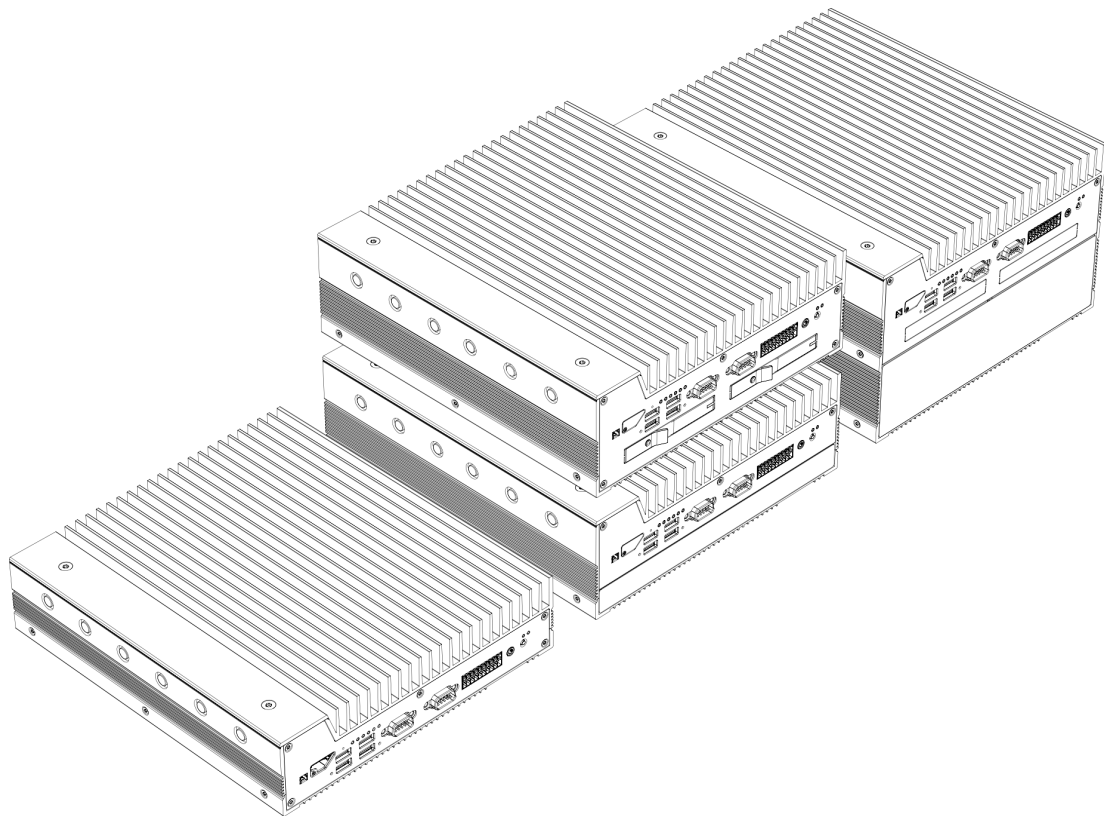

## 1.1 - Accessories

- 5-pin Power Terminal Block Connector (Dinkle 2ESDVM-05P)
- 20-pin DIO/CAN/SW Terminal Block Connector (Dinkle 0159-0320)
- SATA Power and Data Cables if not installed (OnLogic CBD123)

If you purchased additional items such as mounting brackets, power supplies or antennas, they will be located in the system box or within the outer shipping carton.









All drivers and product guides can be found on the corresponding product page. For more information on accessories and additional features, visit the Karbon 800 pages at:

US: <https://www.onlogic.com/k801/>  
<https://www.onlogic.com/k802/>  
<https://www.onlogic.com/k803/>  
<https://www.onlogic.com/k804/>

EU: <https://www.onlogic.com/eu-en/k801/>  
<https://www.onlogic.com/eu-en/k802/>  
<https://www.onlogic.com/eu-en/k803/>  
<https://www.onlogic.com/eu-en/k804/>

## 1.2 - Product Specifications

OnLogic Karbon 800 Series	
<b>Variants</b>	K801 - High-Performance Rugged Low-Profile Computer K802 - High-Performance Rugged Computer w/ModBay K803 - High-Performance Rugged Computer w/PCIe K804 - High-Performance Rugged Computer w/ModBay & PCIe
<b>Processor</b>	Intel 12th Gen Alder Lake-S (LGA1700) Core i3, i5, i7 & i9 up to 16-core 24-thread
<b>Memory</b>	2x DDR4-3200 SO-DIMM up to 64GB total (non-ECC or ECC)
<b>Chipset</b>	Intel W680
<b>Integrated Graphics</b>	Intel UHD Graphics 730 (i3) or 770 (i5, i7, i9)
<b>Front I/O</b>	4x USB 3.2 Gen 2 Type-A 2x Serial RS-232/422/485 20-pin GPIO terminal block (DIO, CAN bus, Ext. switch) 1x 3.5 mm audio jack 2x 3FF Mini-SIM slots 1x External fan connector 2x Hot-swap drive bays (optional, K802 & K804) 8x Status LEDs 1x Power button
<b>Back I/O</b>	2x or 6x 2.5 GbE LAN (optional 2x PoE) 2x USB 3.2 Gen 2 Type-A 2x DisplayPort (full-size, DP 1.4, DP++, HDMI 1.4) 2x ModBay expansion slots (K802 & K804) 5-pin Power input
<b>Expansion &amp; Storage</b>	1x M.2 2280 M-key (PCIe Gen 4 x4) 1x M.2 2280 M-key (PCIe Gen 4 x4, SATA) 1x M.2 3042/3052/2280 B-key (PCIe x2, SATA, USB 3.0, USB 2.0) 1x M.2 2230 E-key (PCIe x1, USB 2.0) 1x mPCIe (PCIe x1, USB 2.0) 1x PCIe Gen 5 x16 slot (K803 & K804) 2x 2.5" SATA (1x K803, 2x K802 & K804)
<b>Special Features</b>	User-Programmable OnLogic Microcontroller (MCU) Automotive Ignition Power Sensing Optional TPM 2.0 module (Nuvoton NPCT750)
<b>Operating Systems</b>	Windows 10, Windows 11, Ubuntu 22.04 (Kernel 5.16 and higher)
<b>LAN Controllers</b>	1x Intel I225-LM with AMT support 1x or 5x Intel I225-IT
<b>Voltage Input</b>	12 ~ 48V DC up to 30A (19 ~ 48V DC with PCIe expansion over 75W)
<b>Dimensions</b>	K801 = 240 x 50 x 267mm (9.45 x 1.97 x 10.51") K802 & K803 = 240 x 82 x 267mm (9.45 x 3.23 x 10.51") K804 = 240 x 143 x 267mm (9.45 x 5.63 x 10.51")
<b>Mounting</b>	Wall Mount Wall Mount with Vibration Isolation DIN Rail Mount

<b>Operating Temperature</b>	-40°C ~ 70°C (35W TDP CPU) -40°C ~ 50°C (65W TDP CPU)
<b>Storage Temperature</b>	-40°C ~ 85°C
<b>Operating Humidity</b>	10~95% relative, non-condensing
<b>Storage Humidity</b>	0~95% relative, non-condensing
<b>Shock &amp; Vibration</b>	Shock: Tested according to IEC 60068-2-27 and MIL-STD-810H Vibration: Tested according to IEC 60068-2-64 and MIL-STD-810H
<b>Certifications</b>	 FCC 47 CFR Part 15 Subpart B (Class A)  EN 60950-1 & EN 63268-1 CISPR 32/EN 55032 CISPR 35/EN 55035 Radio Equipment Directive (2014/53/EU) <b>RoHS</b> RoHS 3 (2015/863/EU)  WEEE Directive (2012/19/EU)  IEC 60068-2-27 IEC 60068-2-64 MIL-STD-810H  Power Immunity According to E-Mark ISO 7637-2 & ISO 16750-2  EN 50121-3-2  IEC 60601-1-2, 4th ed.  EN 60945, 4th ed.



<b>Radio Specifications when equipped with Intel AC 9260 Wi-Fi (device for indoor use)</b>	
<b>Frequency Bands</b>	2.4 GHz and 5 GHz bands
<b>Operating Frequency</b>	2400 - 2485 MHz 5150 - 5250 MHz, 5250 - 5350 MHz 5470 - 5725 MHz, 5725 - 5878 MHz
<b>Channel spacing / Bandwidth</b>	2.4GHz: 802.11b/g/n; 5 MHz / BT: 1MHz Bandwidth: 20 MHz / 40 MHz 5 GHz: 802.11a/n/ac: 20, 40, 80, 160 MHz
<b>RF output power</b>	20 dBm (2400-2485 MHz) IEEE 802.11b/g/n & BT 10 dBm (2400-2485 MHz) BLE 23 dBm (5150-5725 MHz) IEEE 802.11a/n/ac 13.98 dBm (5725-5875 MHz) IEEE 802.11a/n/ac
<b>Type of Modulation</b>	2.4 GHz: DSSS/OFDM/FHSS 5 GHz: OFDM
<b>Type of Antenna</b>	Reference antenna is PIFA type (2 dBi/2 dBi gain)
<b>Modes of operation</b>	Duplex (Tx/Rx)
<b>Duty cycle (access protocol)</b>	As In: IEEE 802.11a/b/g/n/ac

## 1.3 - Exterior Features & Dimensions

### 1.3.1 - Front I/O

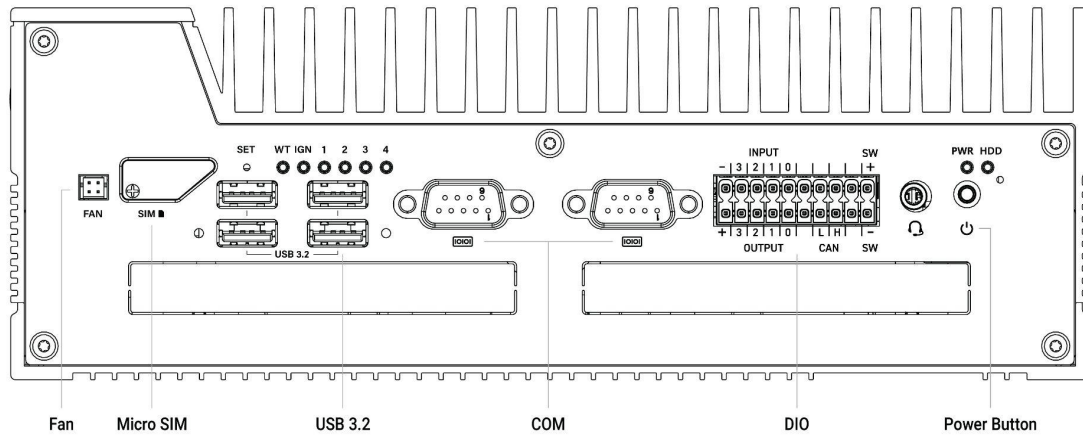

### 1.3.2 - Back I/O

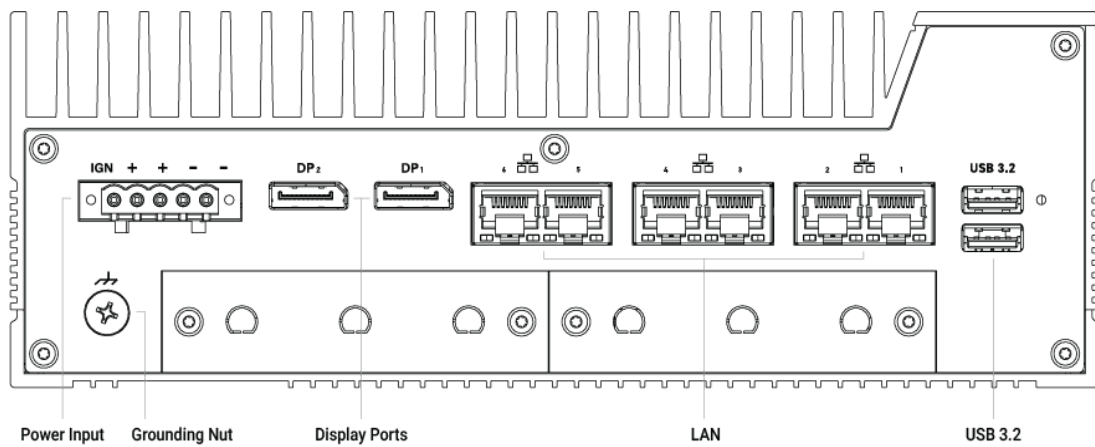

### 1.3.3 - K801 System Dimensions

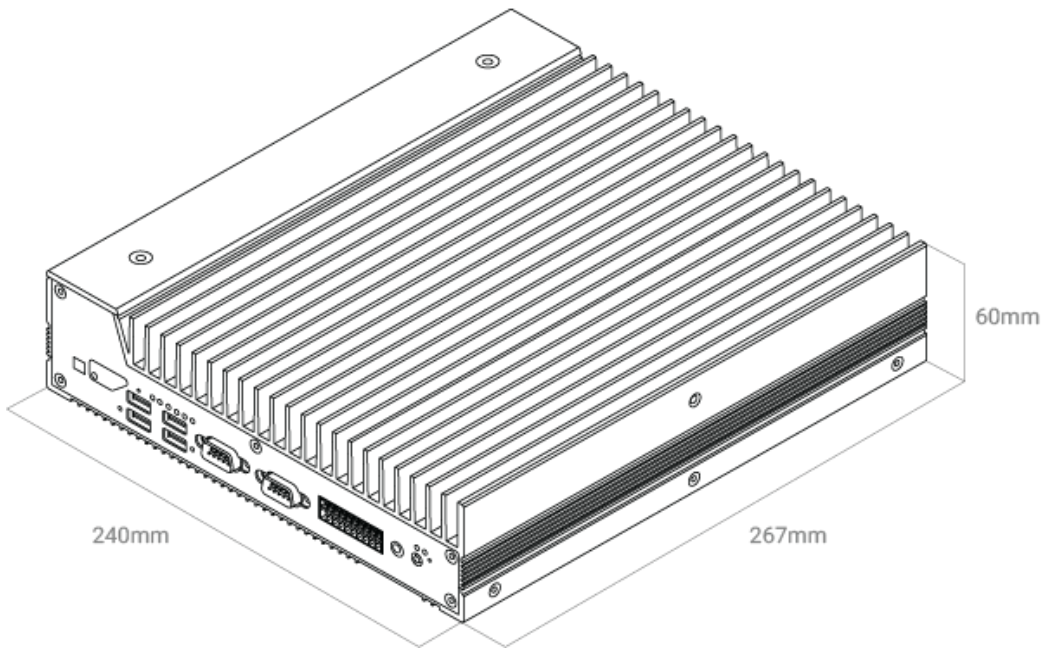

### 1.3.4 - K802 System Dimensions

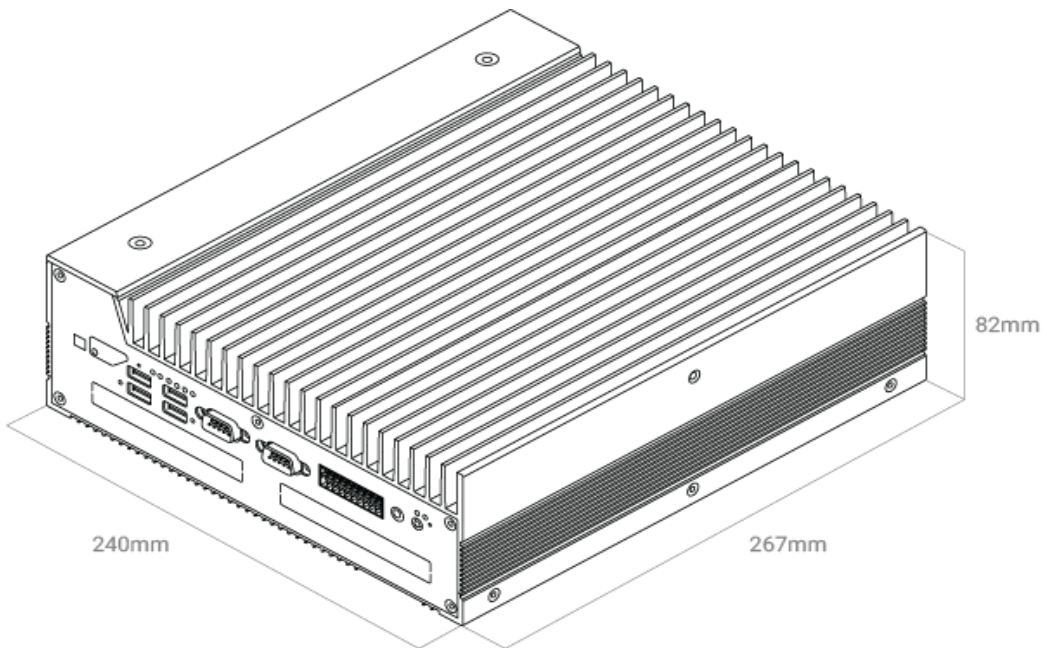

### 1.3.5 - K803 System Dimensions

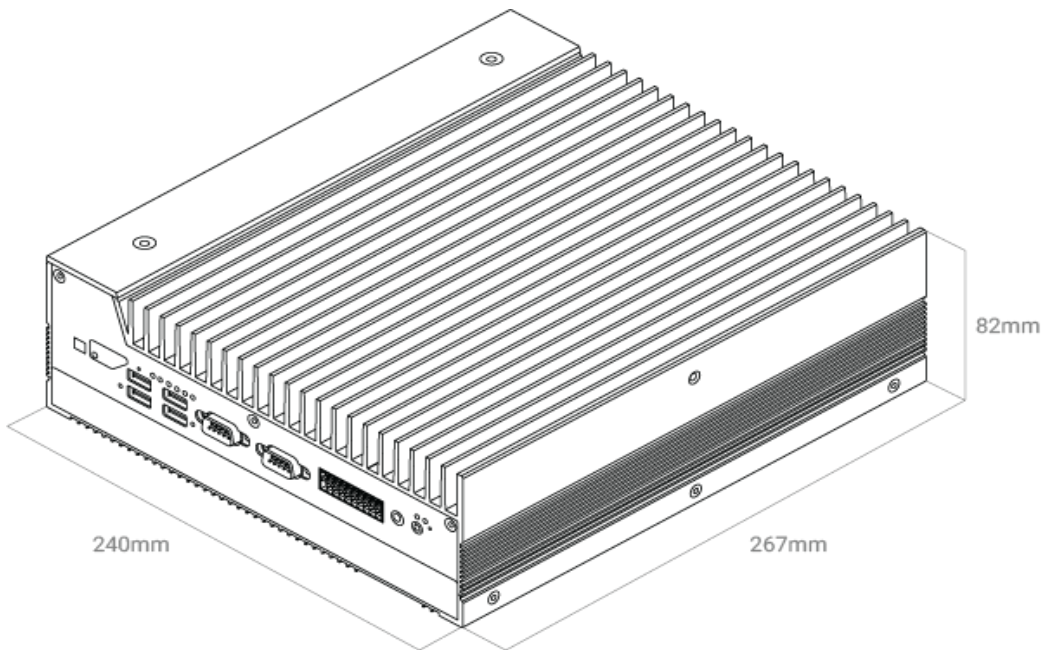

### 1.3.6 - K804 System Dimensions

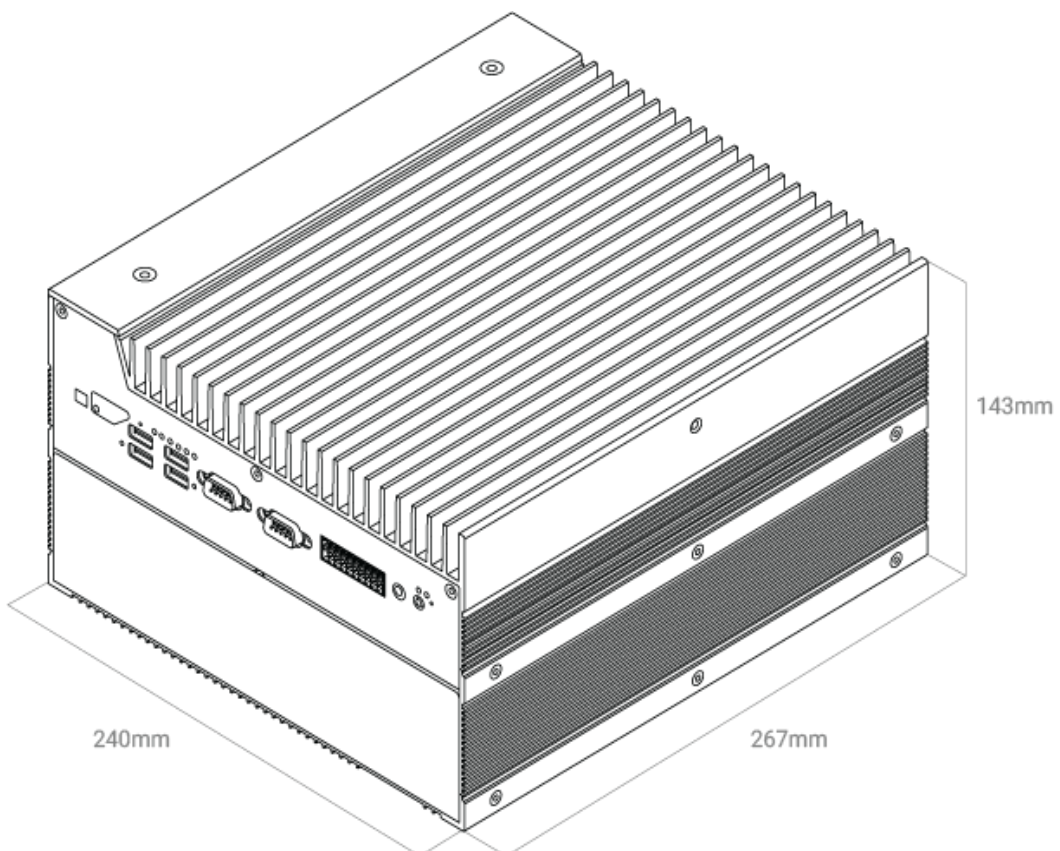

# 1.4 - Motherboard Overview

## 1.4.1 - System Block Diagram

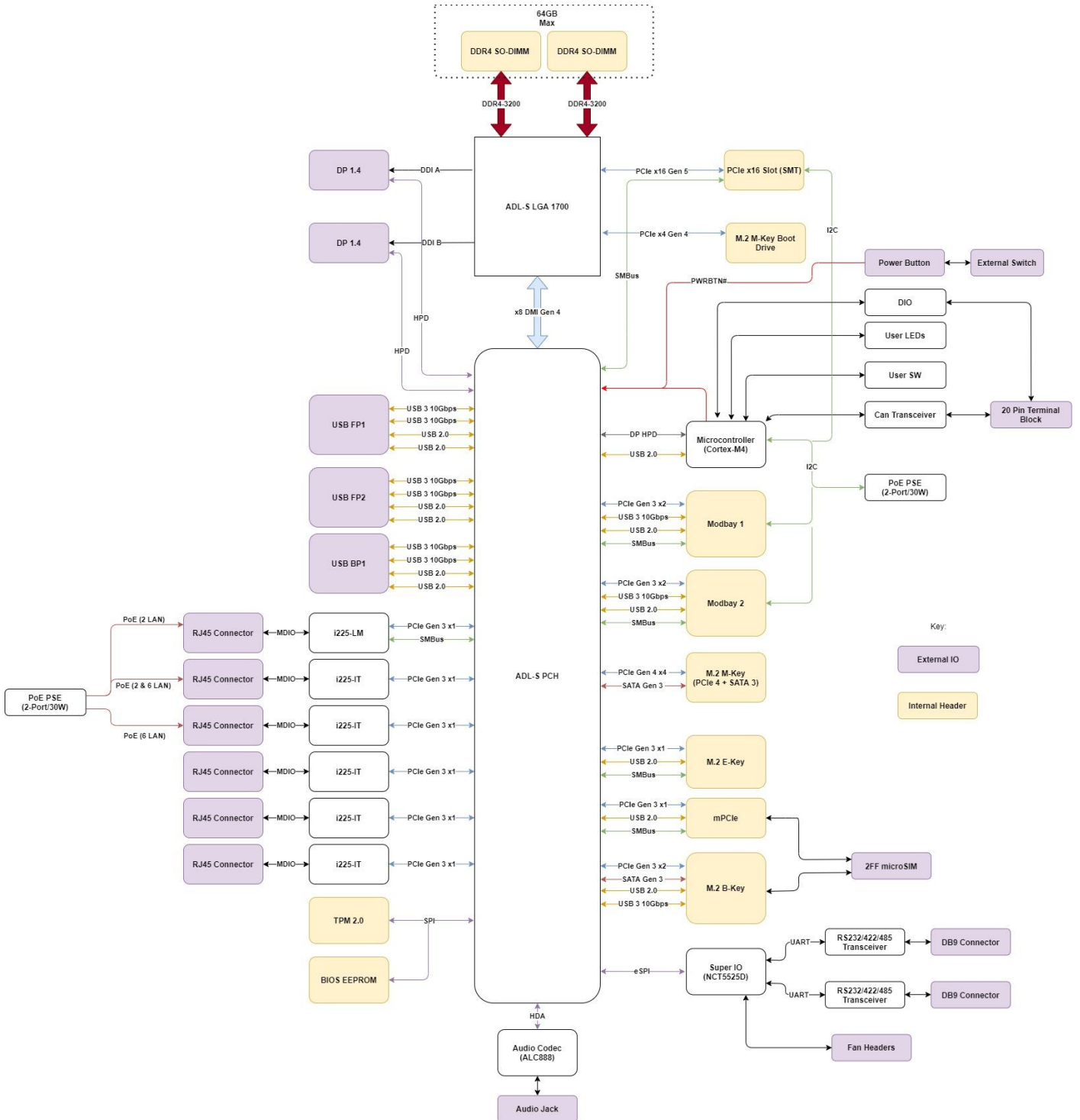



## 1.4.2 - Motherboard Features

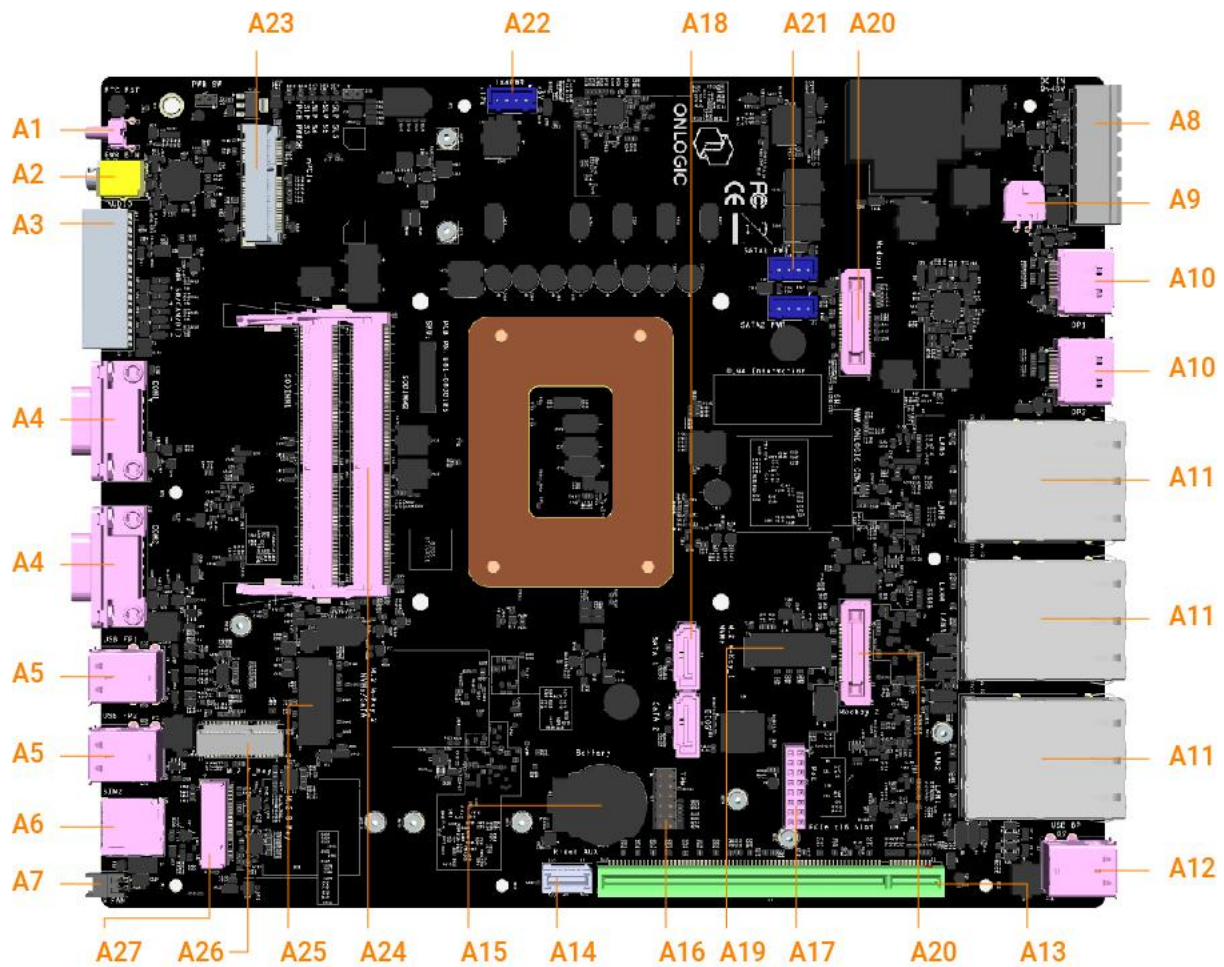

Item	Description
A1	Power button
A2	Audio Jack
A3	8-bit Isolated DIO (4-in, 4-out), CAN bus, External Switch
A4	COM RS-232/422/485 ports (2x)
A5	USB 3.2 Gen 2 Type-A ports (4x)
A6	3FF Mini-SIM slots (2x)
A7	External fan header
A8	5-pin Power input with ignition sense
A9	Auxiliary power for GPU Power card
A10	DisplayPorts (2x)
A11	2.5 GbE LAN ports (2x or 6x)

A12	USB 3.2 Gen 2 Type-A ports (2x)
A13	PCIe Gen 5.0 x16 connector
A14	PCIe Aux power and fan control header
A15	CMOS battery
A16	TPM header
A17	Onboard PoE header
A18	SATA III ports (2x)
A19	M.2 2280 M-key (PCIe Gen 4 x4)
A20	ModBay connectors (2x)
A21	SATA power headers (2x)
A22	4-pin Aux power expansion (12V, 5V)
A23	mPCIe slot (PCIe Gen 3 x1, USB 2.0)
A24	DDR4 SO-DIMM slots (2x)
A25	M.2 2280 M-key slot (PCIe Gen 4 x4, SATA)
A26	M.2 2230 E-key slot (PCIe Gen 3 x1, USB 2.0)
A27	M.2 3042/3052/2280 B-key slot (PCIe Gen 3 x2, USB 3.0, USB 2.0)

## 2 - I/O Definitions

### 2.1 - Serial Ports

The serial ports on the Karbon 800 series motherboard support RS-232, RS-422 Full-Duplex, and RS-485 half-Duplex configurations. The serial port communication mode can be selected in the BIOS configuration. In addition, 5V & 12V power can be enabled on pin 9 in the same BIOS menu. Pin 9 is rated to provide 250mA of current. Refer to the BIOS manual for configuration instructions.

Pin	RS-232	RS-422	RS-485
1	DCD	TX-	TX-/RX-
2	RX	TX+	TX+/RX+
3	TX	RX+	NC
4	DTR	RX-	NC
5	GND	NC	NC
6	DSR	NC	NC
7	RTS	NC	NC
8	CTS	NC	NC
9	RI/PWR	NC/PWR	NC/PWR



## 2.2 - DIO, CAN, Ext. Power Switch

The Karbon 800 series 20-Pin header provides the following interfaces: 8-bit (4-in, 4-out) Digital Input Output (DIO) or General Purpose Input Output (GPIO) with optically isolated terminals, one CAN bus connection, and an optional external power switch connection.

The DIO is optically isolated, meaning that the terminal is separated from other motherboard features for protection. The DIO terminal requires external power from a 5~48V DC source through Pin 20 with GND to Pin 19 in order to function.

The Isolated Power Supply (ISO PSU) can be a voltage source from 5~48V to interface with external digital IO. The maximum power draw from the supply should not exceed 0.6A under normal operating conditions. Individual DOut pins will be damaged by loads in excess of 150mA. The ISO PSU must be a DC Limited Power Source (LPS) power supply.

Mating power switch cables should be a twisted-pair wire with floating shield to assure proper immunity to EMI/RFI. It is recommended to keep wires at less than 3 meters in length. Any remote power switch connected between pins 1 and 2 should be momentary contact type only.

Pin	Definition	Pin	Definition
1	SW+	2	GND
3	GND	4	GND
5	GND	6	CANH
7	GND	8	CANL
9	GND	10	GND
11	In0	12	Out0
13	In1	14	Out1
15	In2	16	Out2
17	In3	18	Out3
19	V_DIO-	20	V_DIO+

Karbon 800

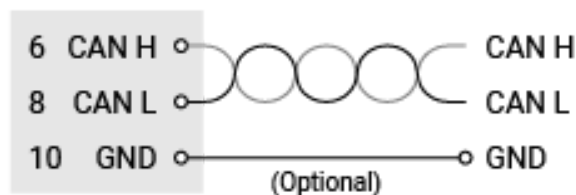

## 2.2.1 - DIO Connection Diagram

Karbon 800



Karbon 800

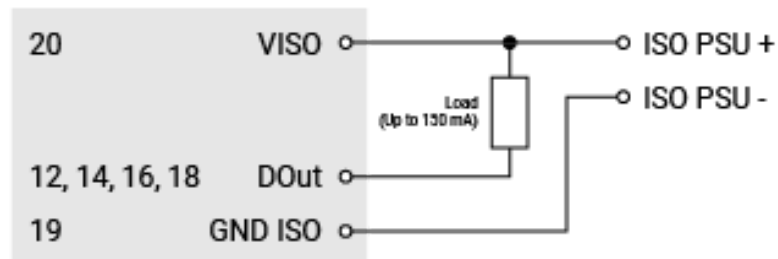

Karbon 800

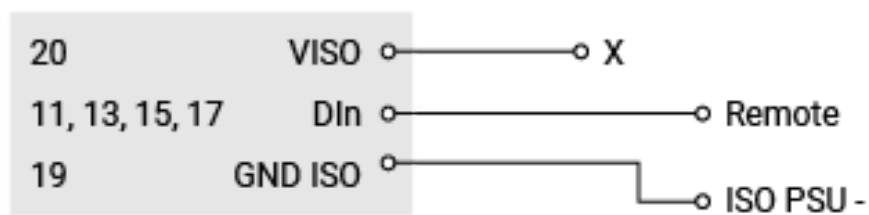

## 2.4 - Status LEDs

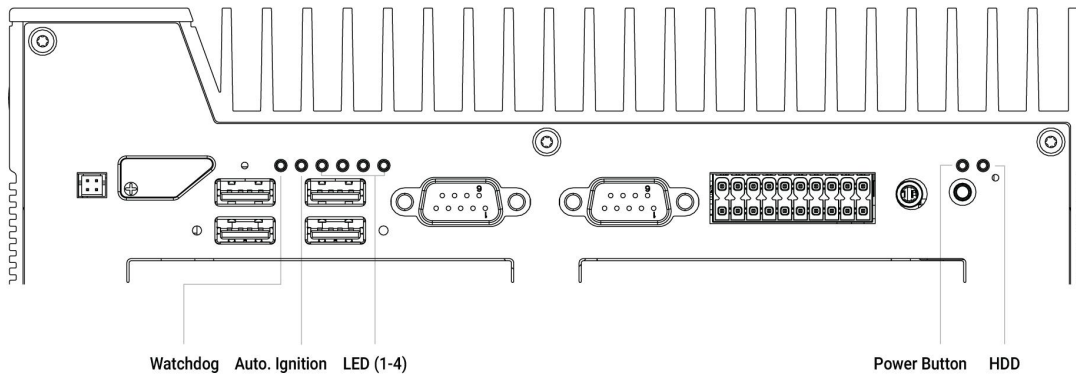

LED	On	Off	Blink	Pulse
<b>LEDs 1-4</b>	Currently selected user mode	-	-	-
<b>Watchdog</b>	MCU is not functioning normally	MCU is not functioning normally	Firmware bootloader is active	MCU is functioning normally
<b>Automotive Ignition</b>	Ignition input to device is on	Ignition input to device is off	-	-
<b>Power</b>	Device is on	Device is off	Device is asleep	-
<b>HDD</b>	-	-	Internal storage drive activity	-

	LED 1	LED 2	LED 3	LED 4	LED 5	LED 6	LED 7	LED 8
<b>Color</b>	White	Blue	White	White	White	White	White	White
<b>Function</b>	SSD Activity Off = None On = R/W	Power	Automotive Ignition Sensing	Watchdog Timer & User Configurable	User Configurable	User Configurable	User Configurable	User Configurable

## 2.5 - Automotive Ignition Power Sensing (IGN)

The Karbon 800 series 5-pin power input terminal offers automotive ignition sensing. The ignition sensing timing for power on and off delays can be modified through OnLogic's microcontroller (MCU) using serial commands. These commands can be used to enable or disable the ignition sensing feature, to set the timing delay for system startup after ignition is detected, and to set the timing delay for system soft and hard shutdown after ignition is lost. For more information on ignition power sensing, and instructions on how to use the serial commands from Windows or Linux, visit OnLogic's support site: <https://www.onlogic.com/support/documentation/karbon-series-ignition-sensing/>

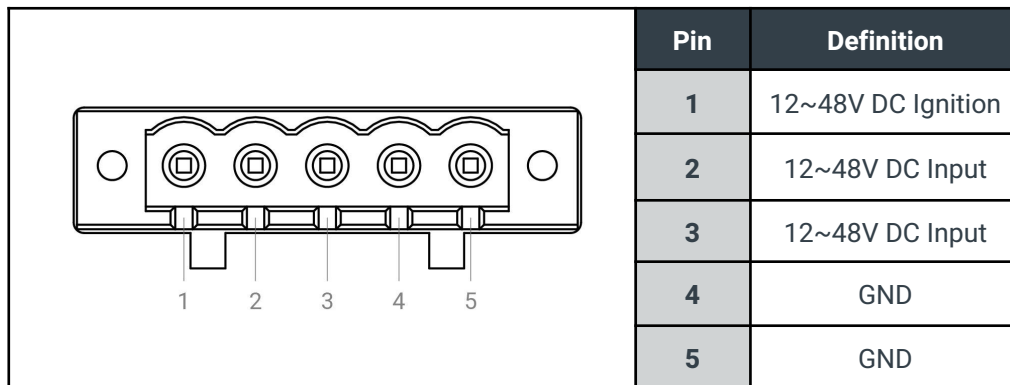
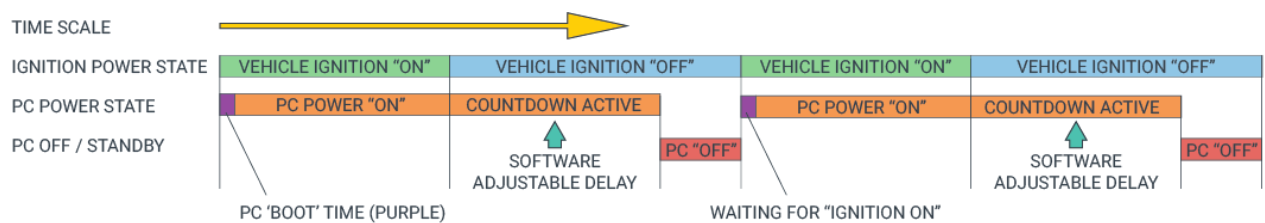

The system should always be used with the supplied 5-pin terminal block and power input should use all 4 power pins (2~5).

The system is operational from 12V~48V DC and the maximum rated current of the connector is 15A per pin. A minimum wire gauge of 16 AWG is recommended for 24V installations. Higher power or lower voltage configurations may necessitate a heavier gauge power harness to reduce power loss in the cabling. Always use a wire gauge that is rated for the operational current of your configuration.

When connecting to the mating terminal block plug, only multi-strand wire with a crimped ferrule end should be used. The terminal block screws must be torqued to the rated value (0.5 Nm).

## 2.7 - Networking

The Karbon 800 series features up to six 2.5 GbE LAN ports. Two of these LAN ports are PoE capable using an optional onboard module. When the PoE module is installed, the two PoE ports will provide up to 32W of combined power. This power output is enough to support a single port up to 25.5W (IEEE 802.3at), two ports up to 15.4W each (IEEE 802.3af), or two ports with a combined draw up to 32W (e.g. 7W and 25W).

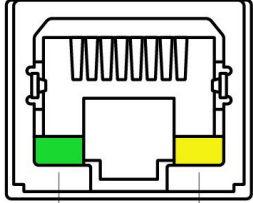
	LED	Color	State	Condition
 <p>Link LED (Green)    Speed LED (Green/Yellow)</p>	Link	-	Off	LAN link not established
		Green	On	LAN link established
			Blinking	LAN activity occurring
Speed	-	Off	100 or 10 Mb/s data rate	
	Yellow	On	1000 Mb/s data rate	
	Green	On	2500 Mb/s data rate	

The Karbon 800 supports additional LAN expansion using OnLogic ModBay cards. ModBay cards can be used to add up to eight additional RJ45 LAN or PoE ports, or up to six additional M12 X-coded LAN or PoE ports. The ModBay LAN and PoE expansion cards provide 1 GbE LAN ports using dedicated Intel I210-IT network controllers for each port. Maximum ModBay PoE power output depends on the system voltage input, total system power draw, and operating temperature.

## 2.8 - USB Ports

There are six USB 3.2 Gen 2 Type A ports on the Karbon 800 series. All six USB ports are capable of delivering 10 Gbps of bandwidth per port and are rated to 5V @ 900mA of power delivery per USB-IF specification. Optional ModBay cards can be used to add up to eight additional USB 3.2 Gen 2 ports. All USB ports also support USB 2.0 connectivity. Refer to Appendix C for PoE power budgets.

## 2.9 - DisplayPort

There are two full-size DisplayPorts on the Karbon 800 series. Both ports support DP 1.4 at 4K 60Hz and support MST (Multi Stream Topology). An MST hub can be used to support up to four independent displays. Please refer to Intel documentation for additional Alder Lake-S display output specifications: <https://ark.intel.com/>

## 2.10 - SIM Cards

Two 3FF Micro-SIM card slots are available on the front panel of the Karbon 800 platform allowing native support for 4G LTE and 5G cellular modems. The SIM signals can be directed to either the mPCIe or M.2 3042/3052/2280 B-key internal expansion slots. Both SIM signals can be connected to the M.2 3042/3052/2280 B-key to support modems with SIM failover capability. This selection is controlled in BIOS. The default BIOS setting will connect SIM1 to the mPCIe and SIM2 to the M.2 3042/3052/2280 B-key. Please refer to the BIOS user manual for additional information.

The SIM slot is a Push-Push type slot. To insert or remove the SIM card from the front panel of the Karbon platform, please use a small implement to push the card into the slot until it clicks. To remove the card, push with a small implement until the card clicks, then pull on the free end of the card to remove it.

## 2.11 - RTC Reset Button

Karbon 800 series features an RTC reset button that can be accessed using a paperclip or SIM card removal tool. Be sure the system is powered off and unplugged before resetting with the button. The RTC reset button is found next to the power button.

## 2.12 - Modbay Expansion

The Karbon 800 series K802 and K804 models feature two Modbay expansion slots. Each slot supports PCIe Gen 3 x2, USB 3.1 Gen 2, and USB 2.0. OnLogic offers a variety of ModBay cards including RJ45 LAN or PoE, M12 LAN or PoE, USB 3, and a carrier card with two additional mPCIe slots.

### 2.12.1 - Modbay 4x LAN Expansion

The 4x LAN Expansion (MODBAY-4LAN01) adds additional RJ45 GbE LAN ports to the K802 and K804. This ModBay uses dedicated Intel I210-IT network controllers for each port which support speeds up to 1 Gbps.

Operating Temperature: -40~70°C

### 2.12.2 - Modbay 4x PoE Expansion

The 4x PoE Expansion (MODBAY-4POE01) adds additional RJ45 GbE PoE LAN ports to the K802 and K804. This ModBay uses dedicated Intel I210-IT network controllers for each port which support speeds up to 1 Gbps. Additionally, each port supports PoE output. The power budget for PoE is dependent on the voltage of the system power input. Refer to Appendix C for PoE power budgets.

Operating Temperature: -40~70°C

### 2.12.3 - Modbay 3x M12 LAN Expansion

The 3x M12 LAN Expansion (MODBAY-M12LAN01) adds additional M12 X-coded GbE LAN ports to the K802 and K804. This ModBay uses dedicated Intel I210-IT network controllers for each port which support speeds up to 1 Gbps.

Supported cables:

- CABLE-M12-RJ45-5M (5 Meter X-coded M12 to RJ45)
- CABLE-M12-RJ45-10M (10 Meter X-coded M12 to RJ45)

Operating Temperature: -40~70°C

### 2.12.4 - Modbay 3x M12 PoE Expansion

The 3x M12 PoE Expansion (MODBAY-M12POE01) adds additional M12 X-coded GbE PoE LAN ports to the K802 and K804. This ModBay uses dedicated Intel I210-IT network controllers for each port which support speeds up to 1 Gbps. Additionally, each port supports PoE output. The power budget for PoE is dependent on the voltage of the system power input. Refer to Appendix C for PoE power budgets.

Supported cables:

- CABLE-M12-RJ45-5M (5 Meter X-Coded RJ45 to M12)
- CABLE-M12-RJ45-10M (10 Meter X-Coded RJ45 to M12)

Operating Temperature: -40~70°C

### 2.12.5 - Modbay 2x 10Gb LAN Expansion

The 2x 10Gb LAN Expansion (MODBAY-10GLAN01) adds RJ45 10 GbE LAN ports to the K802 and K804. This ModBay uses a single X550 network controller which supports individual port speeds up to 10 Gbps and a maximum combined speed up to 15 Gbps across both ports. Additionally, this expansion card is only rated to an operating temperature of 0~50°C due to the X550 controller.

Operating Temperature: -40~40°C

### 2.12.6 - Modbay 4x USB3 Expansion

The 4x USB3 Expansion (MODBAY-4USB01) adds additional USB 3.2 Gen 2 Type-A ports to the K802 and K804. This ModBay uses two USB controllers which support individual port speeds up to 10 Gbps and a maximum combined speed up to 15 Gbps across all ports. The controllers are the ASM3142 (PCIe Gen 3 x2 to 2x USB 3.2 Gen 2) and the USB7206i (1x USB 3.2 Gen 2 to 2x USB 3.2 Gen 2). Each

port is rated to 5V @ 900mA of power delivery per USB-IF specification. These ports can only wake in Modern Standby and are not active in Sleep and Hibernate system states.

Operating Temperature: -40~50°C

## 3 - Motherboard Connectors

### 3.1 - M.2 2280 M-key 1

This expansion slot is capable of supporting PCIe Gen 4 x4 and is routed directly to the CPU. This slot is designed to support NVMe storage drives. A full pinout table for this expansion slot is provided in Appendix C.

### 3.2 - M.2 2280 M-key 2

This expansion slot is capable of supporting PCIe Gen 4 x4 or SATA III and is routed to the chipset. This slot is designed to support NVMe or SATA storage drives. A full pinout table for this expansion slot is provided in Appendix C.

### 3.3 - M.2 3042/3052/2280 B-key

This expansion slot is capable of supporting PCIe Gen 3 x2, SATA III, USB 3.2 Gen 2, USB 2.0, and dual SIM card inputs from the external I/O. This slot is designed to support various expansion cards such as SATA storage drives and 4G LTE or 5G cellular cards. A full pinout table for this expansion slot is provided in Appendix C.

The SIM1 and SIM2 3FF Micro-SIM card slots are connected to this slot. The routing can be selected in the BIOS. The default setting routes SIM1 to the mPCIe slot and SIM2 to the M.2 B-key slot, but both SIM cards can be routed to the M.2 B-key slot to support modems with SIM failover capability. Please refer to the BIOS user manual (Appendix B) for more information.

### 3.4 - M.2 2230 E-key

This expansion slot is capable of supporting PCIe Gen 3 x1 and USB 2.0 signals. This slot is designed to support M.2 2230 Wi-Fi expansion cards. A full pinout table for this expansion slot is provided in Appendix C.

### 3.5 - mPCIe

This expansion slot is capable of supporting PCIe Gen 3 x1, USB 2.0, and SIM card input from the external I/O. This slot is designed to support full-length cards. Half-length cards can be installed using an adapter. A full pinout table for this expansion slot is provided in Appendix C.



The SIM1 3FF Micro-SIM card slot is multiplexed to both the mPCIe and M.2 B-key slots. The default setting routes SIM1 to the mPCIe slot and SIM2 to the M.2 B-key slot. Please refer to the BIOS user manual (Appendix B) for more information.

## 3.6 - TPM Header

The Karbon 800 series supports an optional discrete TPM 2.0 module. OnLogic offers a wide-temp TPM 2.0 module based on the Nuvoton NPCT750 (SKU: TPM01).

## 3.7 - Onboard PoE Header

The Karbon 800 series has a PoE header which uses an optional module to enable PoE on two of the onboard 2.5 GbE LAN ports. On the two LAN models, both ports 1 and 2 will have PoE enabled. On the six LAN models, ports 2 and 3 will have PoE enabled which leaves port 1 as the AMT-enabled remote management port. Please refer to section [2.7 Networking](#) for additional PoE output information.

## 3.8 - Aux Power Expansion Header

The Karbon 800 series has a power header that can support up to 2A of 5V and 12V power. This header is designed for internal expansion cards that require additional power above what is provided by the expansion slots.

## 3.9 - SATA Headers

There are two SATA data and SATA power headers on the Karbon 800 motherboard. The data ports support SATA III 6Gbps storage devices. Each SATA power header delivers 12V and 5V output. The OnLogic CBD123 SATA data and power cable is recommended for use with these ports and 2.5" SSD storage drives.

## 3.10 - PCIe Gen 5.0 x16 Connector

The Karbon 800 series features one PCIe x16 connector on the motherboard. This connector is paired with OnLogic risers to support multiple PCIe configurations in the K803 and K804 models.

### 3.10.1 - PCIe x16 Riser (K803)

This riser supports a single-height PCIe Gen 4 x16 expansion card in the K803. There is one fan header on the riser as well to support the fan in the chassis. The K803 will fit PCIe cards up to 4.4" H x 9.5" L x 0.57" W (111.8 x 241.3 x 14.5 mm).

### 3.10.2 - PCIe x16 Riser (K804)

This riser supports a dual-height PCIe Gen 4 x16 expansion card in the K804. Additionally, there are six SATA power headers to support a 6x 2.5" SSD RAID array when paired with a discrete RAID

adapter, and fan headers to power the internal fans in the K804 PCIe expansion bay. The K804 will fit PCIe cards up to 4.8" H x 10" L x 1.37" W (121.9 x 254 x 34.8 mm).

### 3.10.3 - Dual PCIe x8 Riser (K804)

This riser supports two single-height PCIe Gen 4 x16 expansion cards in the K804. The slots will mechanically accept PCIe x16 cards, however each slot will only provide PCIe Gen 4 x8 lanes. K804 will automatically detect this riser and enable bifurcation of the native PCIe x16 slot on the motherboard. There are fan headers on the riser to power the internal fans in the K804 PCIe expansion bay.

## 3.11 - DDR4 SO-DIMM Slots

The Karbon 800 series supports up to two DDR4 SO-DIMM slots rated up to 3200MHz. The system will support non-ECC memory with all CPU options and ECC memory with a Core i5 (Except i5-12400), i7 and i9 CPUs.

## 4 - Mounting Instructions

For a full set of mounting options and instructions, see the...

1. [K801 Spec Sheet and Dimensional Drawings](#)
2. [K802 Spec Sheet and Dimensional Drawings](#)
3. [K803 Spec Sheet and Dimensional Drawings](#)
4. [K804 Spec Sheet and Dimensional Drawings](#)

## 5 - OnLogic Microcontroller (MCU)

### 5.1 - Overview

The microcontroller on Karbon 800 series controls several systems, including:

- Automotive ignition power sensing
- CAN bus
- DIO
- Status LEDs
- DisplayPort CEC and persistent EDID
- Input voltage monitoring
- RTOS Capabilities

A segment is exposed for user control via two serial ports. By reading and writing to these serial ports, the user can send and receive CAN messages, read/set the DIO state, and select from a number of configuration options. One port is dedicated to Karbon 800's CAN bus, while the other doubles as a serial terminal and the DIO interface. Any configuration settings may be saved to non-volatile memory which means the MCU settings will be retained during a long power-off.

The serial interfaces can be controlled through Pykarbon, the karbon series' very own MCU interface tool. The Pykarbon module is designed to be a simple and easy tool for configuring your system to meet your needs and applications. Visit [OnLogic's Pykarbon GitHub page](#) for specific information regarding using the interface tool.

Refer to our support website for further details and instructions:

<https://support.onlogic.com/documentation/karbon800/>

## 6 - Power Management

### 6.1 - Wake-Up Events

Karbon 800 supports multiple power states. The wake-up events can be configured in the MCU and BIOS. This section describes the power management functions you can perform and gives information on protection circuitry for power adapters.

Wake-Up Event	From ACPI State	Comments
Power Button	Deep S5, S5, S3	
Ignition	Ultra-low power, Deep S5, S5, S3	Must be enabled in MCU
Digital Input	S5, S3	Must be enabled in MCU
LAN	S3	Must be enabled in BIOS
USB	S3	
RTC Alarm	S5, S3	Must be enabled in BIOS

### 6.2 - Protection Circuitry

Parameter	Value
Nominal operating voltage (Rated DC value of input)	12~48V
Undervoltage protection trip DC level (system turns off)	7.6V
Overvoltage protection trip DC level (system turns off)	52.5V
Maximum safe DC voltage (system not damaged)	56V
Minimum safe reverse voltage (system not damaged)	-36V
Ignition pin safe working voltage (system not damaged)	56V

These DC levels specified are the absolute max values for the pins for function and safety of the system. The protection circuitry allows for brief transient voltages above these levels without the system turning off.

## 7 - Regulatory Compliance

### 7.1 - CE

The computer system was evaluated for medical, IT equipment, automotive, maritime and railway EMC standards as a class A device. The computer complies with the relevant IT equipment directives for the CE mark. Modification of the system may void the certifications. Testing includes: EN 55032, EN 55035, EN 60601-1, EN 62368-1, EN 60950-1, EN 50121-3-2, EN 60945 and UN Regulation No. 10 ISO 17650-2 & ISO 7637-2.

### 7.2 - FCC Statement

This device complies with part 15 of the FCC rules as a Class A device. Operation is subject to the following two conditions: (1) this device may not cause harmful interference and (2) this device must accept any interference received, including interference that may cause undesired operation.

### 7.3 - ISED

This device complies with Industry Canada license-exempt RSS standard(s). Operation is subject to the following two conditions: (1) this device may not cause interference, and (2) this device must accept any interference, including interference that may cause undesired operation of the device.

Le présent appareil est conforme aux CNR d'Industrie Canada applicables aux appareils radio exempts de licence. L'exploitation est autorisée aux deux conditions suivantes: (1) l'appareil ne doit pas produire de brouillage, et (2) l'utilisateur de l'appareil doit accepter tout brouillage radioélectrique subi, même si le brouillage est susceptible d'en compromettre le fonctionnement.

**CAN ICES-003(A) / NMB-003(A)**

### 7.4 - UKCA

The computer system was evaluated for medical, IT equipment, automotive, maritime and railway EMC standards as a class A device. The computer complies with the relevant IT equipment directives for the UKCA mark.

### 7.5 - VCCI

This is a Class A product based on the standard of the Voluntary Control Council for Interference (VCCI). If this equipment is used in a domestic environment, radio interference may occur, in which case the user may be required to take corrective actions.

この装置は、クラス A 情報技術装置です。この装置を家庭環境で使用すると電波妨害を引き起こすことがあります。この場合には使用者が適切な対策を講ずるよう要求されることがあります。

VCCI-A

## 8. Appendices

### 8.1 - Appendix A: Software Documentation

Additional documentation for the K800 series including drivers, BIOS manuals, and configuration examples can be found on our support website.

<https://support.onlogic.com/documentation/karbon800/>

### 8.2 - Appendix B: System Thermal Results

The thermal performance of the Karbon 800 was validated by loading the system to simulate expected workloads while the test system was exposed to high ambient temperatures in a thermal chamber environment. Two different workloads were considered, a 16-core 35W load and a 16-Core 65W load evaluated up to 70°C in a K801 chassis which is the worst case thermal scenario. The results were analyzed by comparing the average clock speed over the duration of the test to the expected base clock speed.

#### 8.2.1 - Testing Conditions

- Temperature Range: -40 ~ 70°C
- Step size: 10°C (except for a jump from 0°C to 30°C during both tests)
- CPU, SSD, and RAM loaded

#### 8.2.2 - Results Summary

The i9-12900 CPU (65W) was able to maintain above 80% base clock speeds as defined by Intel on both the performance cores and efficiency cores up to 50°C ambient temperature. Significant throttling occurred at higher temperatures under the test workload and the CPU did not have thermal headroom for any additional turbo power.

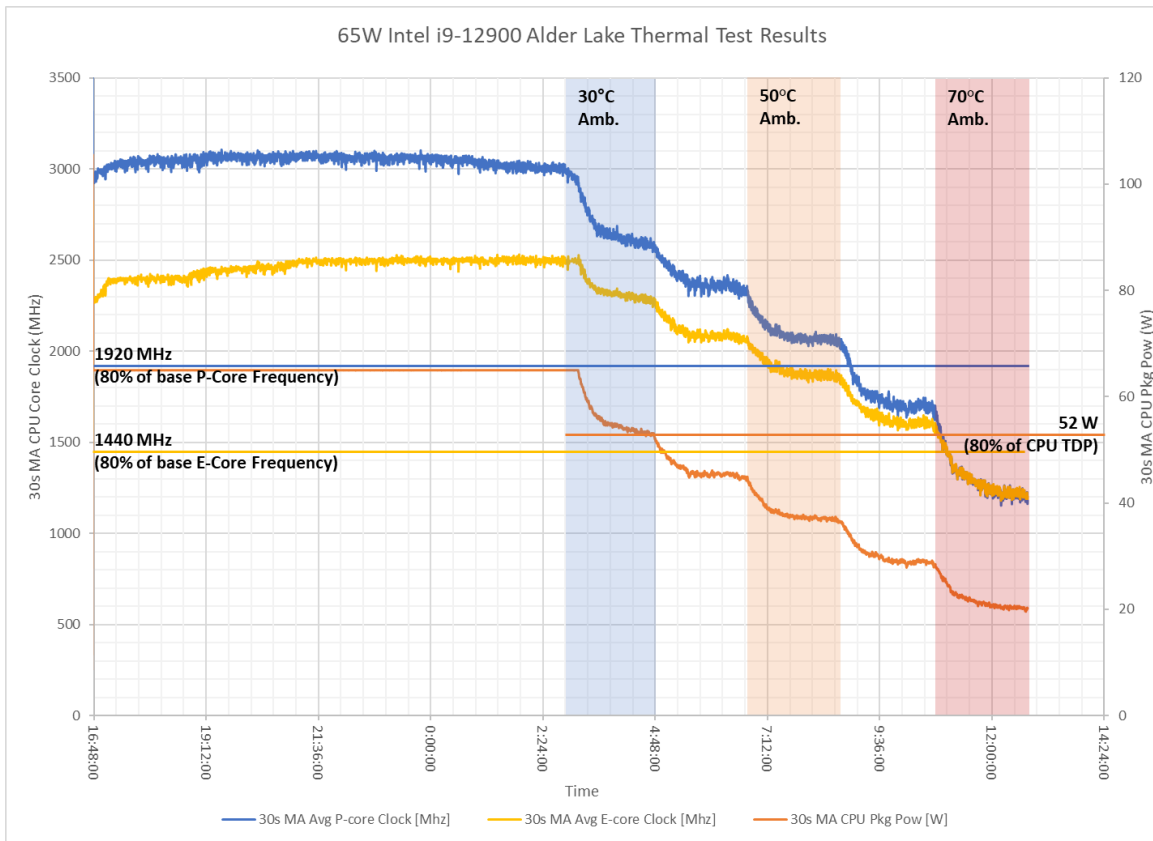

The i9-12900T CPU (35W) was able to maintain above 100% base clock speeds as defined by Intel on both the performance cores and efficiency cores up to 70°C ambient temperature. This indicates that there was thermal headroom for turbo power over the entire 2 hour run at 70°C.

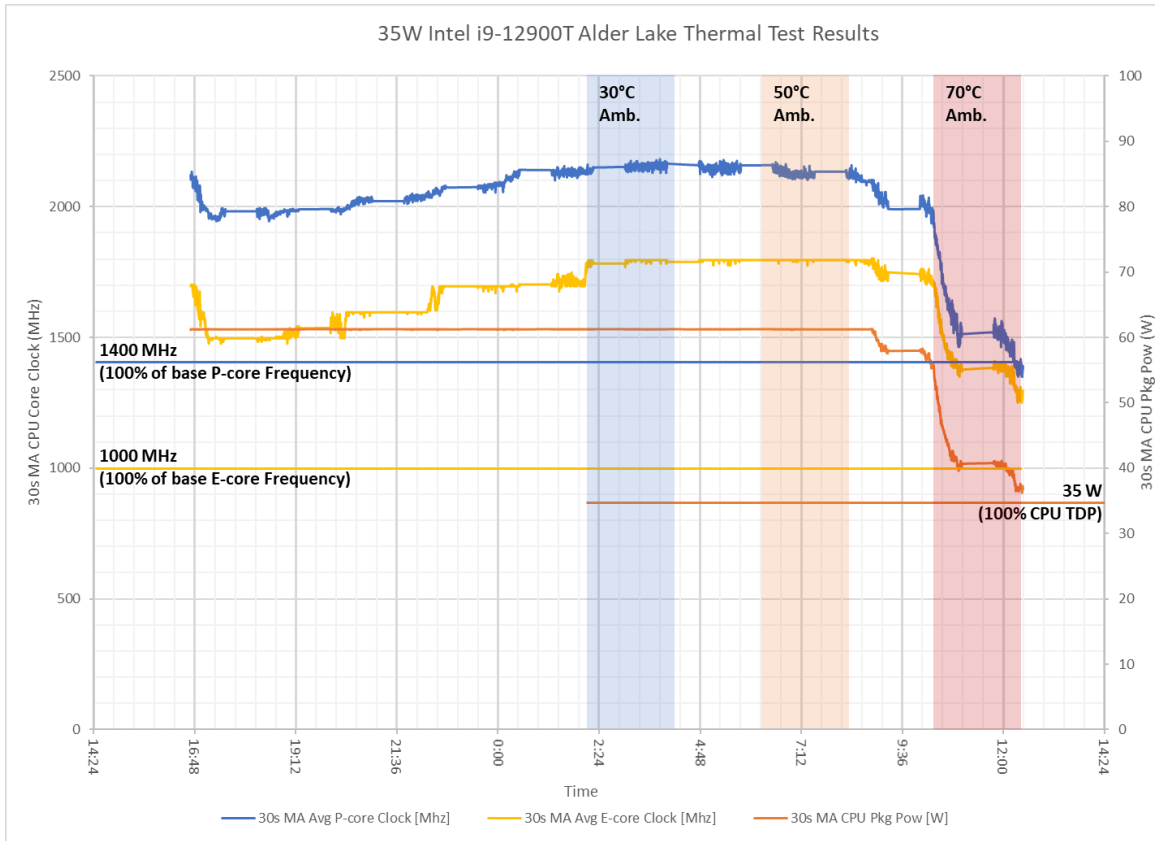

### 8.3 Appendix C: PoE Power Budget

The nominal power budget for all PoE ports on the Karbon 800 series is provided below. These values are provided for room temperature operating conditions. Increased ambient temperature will limit the maximum safe operating power for the Karbon 800 series. Please contact OnLogic for specific derating information for your installation.

	Mobo PoE Exp (2 ports)	Modbay 1 (3-4 ports)	Modbay 2 (3-4 ports)	Notes
12v	<b>802.3at Type II</b>	<b>802.3at Type II</b>	<b>802.3at Type II</b>	Maximum of 100W distributed across all ports
24v	<b>802.3at Type II</b>	<b>802.3at Type II</b>	<b>802.3at Type II</b>	Maximum of 200W distributed across all ports
36-48 v	<b>802.3at Type II</b>	<b>802.3at Type II</b>	<b>802.3at Type II</b>	Maximum of 275W distributed across all ports
Notes	<b>Combined power &lt;30W</b>			



## 8.4 - Appendix D: Expansion Port Pinouts

### 8.4.1 - M.2 B-key Pinout

Pin	Function	Function	Pin
1	CONFIG_3	3.3V	2
3	GND	3.3V	4
5	GND	FULL_CARD_POWER_OFF#	6
7	USB 2.0 D+	W_DISABLE1#	8
9	USB 2.0 D-	NC	10
11	GND	KEY	12
13	KEY	KEY	14
15	KEY	KEY	16
17	KEY	KEY	18
19	KEY	NC	20
21	CONFIG_0	NC	22
23	NC	NC	24
25	NC	GPIO_10/W_DISABLE2#	26
27	GND	NC	28
29	PERn1/USB3.1-Rx-	UIM-RESET	30
31	PERp1/USB3.1-Rx+	UIM_CLK	32
33	GND	UIM_DATA	34
35	PETn1/USB3.1-Tx-	UIM_PWR	36
37	PETp1/USB3.1-Tx+	NC	38
39	GND	NC	40
41	PERn0/SATA-B+	NC	42
43	PERp0/SATA-B-	NC	44
45	GND	NC	46
47	PETn0/SATA-A-	NC	48
49	PETp0/SATA-A+	PERST#	50
51	GND	CLKREQ#	52
53	REFCLKn	PEWAKE#	54
55	REFCLKp	NC	56
57	GND	NC	58
59	NC	NC	60
61	NC	NC	62
63	NC	NC	64
65	NC	SIM_DETECT	66
67	RESET_N	SUSCLK	68
69	CONFIG_1	3.3V	70
71	GND	3.3V	72
73	GND	3.3V	74

75	CONFIG_2		
----	----------	--	--

### 8.4.2 - M.2 M-key Pinout

Pin	Function	Function	Pin
1	GND	3.3 V	2
3	GND	3.3 V	4
5	PERn3	NC	6
7	PERp3	NC	8
9	GND	DAS/DSS (I/O)/LED_1# (I)(0/3.3V)	10
11	PETn3	3.3 V	12
13	PETp3	3.3 V	14
15	GND	3.3 V	16
17	PERn2	3.3 V	18
19	PERp2	NC	20
21	GND	NC	22
23	PETn2	NC	24
25	PETp2	NC	26
27	GND	NC	28
29	PERn1	NC	30
31	PERp1	NC	32
33	GND	NC	34
35	PETn1	NC	36
37	PETp1	DEVSLP (O)	38
39	GND	SMB_CLK (I/O)(0/1.8V)	40
41	PERn0/SATA-B+	SMB_DATA (I/O) (0/1.8V)	42
43	PERp0/SATA-B-	ALERT# (I) (0/1.8V)	44
45	GND	NC	46
47	PETn0/SATA-A-	NC	48
49	PETp0/SATA-A+	PERST# (O)(0/3.3V) or NC	50
51	GND	CLKREQ# (I/O)(0/3.3V) or NC	52
53	REFCLKn	PEWAKE# (I/O)(0/3.3V) or NC	54
55	REFCLKp	NC	56
57	GND	NC	58
59	KEY	KEY	60
61	KEY	KEY	62
63	KEY	KEY	64
65	KEY	KEY	66
67	NC	SUSCLK(32kHz) (O)(0/3.3V)	68
69	PEDET (NC-PCIe/GND-SATA)	3.3 V	70
71	GND	3.3 V	72
73	GND	3.3 V	74
75	GND		

### 8.4.3 - M.2 E-key Pinout

Pin	Function	Function	Pin
1	GND	3.3 V	2

3	USB_D+	3.3 V	4
5	USB_D-	NC	6
7	GND	PCM_CLK	8
9	RESERVED	CNV_RF_RESET#_R	10
11	RESERVED	BT_PCMIN	12
13	GND	BT_PCMOUT	14
15	RESERVED	NC	16
17	RESERVED	GND	18
19	GND	NC	20
21	RESERVED	RESERVED	22
23	RESERVED	KEY	24
25	KEY	KEY	26
27	KEY	KEY	28
29	KEY	KEY	30
31	KEY	RESERVED	32
33	GND	RESERVED	34
35	PETp0	RESERVED	36
37	PETn0	RESERVED	38
39	GND	RESERVED	40
41	PERp0	RESERVED	42
43	PERn0	RESERVED	44
45	GND	RESERVED	46
47	REFCLKp0	RESERVED	48
49	REFCLKn0	SUSCLK(32kHz)	50
51	GND	PERST0#	52
53	CLKREQ0#	W_DISABLE2#	54
55	PEWAKE0#	W_DISABLE1#	56
57	GND	NC	58
59	RESERVED	NC	60
61	RESERVED	NC	62
63	GND	RESERVED	64
65	RESERVED	NC	66
67	RESERVED	NC	68
69	GND	NC	70
71	RESERVED	3.3V	72
73	RESERVED	3.3V	74
75	GND		

#### 8.4.4 - mPCIe Pinout

Pin	Function	Function	Pin
1	WAKE#	3.3V	2
3	NC	GND	4
5	NC	1.5V	6
7	CLKREQ#	UIM_PWR	8
9	GND	UIM_DATA	10
11	REFCLK-	UIM_CLK	12
13	REFCLK+	UIM_RESET	14
15	GND	UIM_SPU	16

17	KEY	KEY	18
17	NC	GND	18
19	NC	W_DISABLE1#	20
21	GND	PERST#	22
23	PERn0	3.3V	24
25	PERp0	GND	26
27	GND	1.5V	28
29	GND	SMB_CLK	30
31	PETn0	SMB_DATA	32
33	PETp0	GND	34
35	GND	USB 2.0_D-	36
37	GND	USB 2.0_D+	38
39	3.3V	GND	40
41	3.3V	NC	42
43	GND	NC	44
45	NC	NC	46
47	NC	1.5V	48
49	NC	GND	50
51	W_DISABLE2#	3.3V	52

## 8.5 - Appendix D: Errata

1. Linux requires Kernel 5.16 or higher to operate as expected.

## 8.6 - Appendix E: Safety Information

Do not open or modify the device. The device uses components that comply with FCC and CE regulations. Modification of the device may void these certifications.

### 8.6.1 - Safe use and installation instructions

1. Install the device securely. Be careful handling the device to prevent injury and do not drop.
2. Equipment is intended for installation in Restricted Access Area
3. To protect against excessive RF exposure, maintain at least 20cm from any user and the RF antennas. Only use provided dual band antennas of 2dBi/2dBi gain.
4. Wall or ceiling mounting device requires use of a mounting plate or bracket. The plate or bracket must be of metal construction and have a minimum thickness of 1mm.
5. Use M4x0.5mm Flat Head screws to attach mounting plate or mounting brackets to threaded holes on bottom or rear of chassis. Screws should be a minimum length of 4mm. Add 1mm of screw length for every mm of additional thickness of plate or bracket beyond 1.5mm.
6. Ambient operating temperature must be between 0 °C to 45 °C with a non-condensing relative humidity of 10-90%.
7. The device can be stored at temperatures between -10 °C to 85 °C.
8. Keep the device away from liquids and flammable materials.
9. Do not clean the device with liquids. The chassis can be cleaned with a cloth.
10. Allow at least 2 inches of space around all sides of the device for proper cooling. If the device is mounted to a vertical surface then recommended device orientation is so that heatsink fins allow air to rise unobstructed. Alternative orientations may result in reduced operational temperature range.
11. This device is intended for indoor operation only.

12. Use UL Listed external power supply with rated output 24-36Vdc.
13. Wiring methods used for the connection of the equipment to the mains supply shall be in accordance with the National Electrical Code, NFPA 70, and the Canadian Electrical Code, Part I, CSA C22.1.
14. Allow ample space for terminal block wiring connections such that the wires do not bend and are protected from accidental damage.
15. Install the device only with shielded network cables.
16. Only use SAE approved cables for automotive installation.
17. The installer should be experienced in aftermarket installation and familiar with general practices for installing electronics devices in vehicles.
18. The device should not be installed in the driver's area of a vehicle.
19. The device should be mounted in accordance with accepted aftermarket practices and materials for vehicle installation.
20. Only use UL Listed connectors for connection to automotive fuse panels.
21. Radio device is not intended for emergency service use.
22. Service and repair of the device must be done by qualified service personnel. This includes, but is not limited to, replacement of the CMOS battery. Replacement CMOS battery must be of the same type as the original.
23. Proper disposal of CMOS battery must comply with local governance.



**WARNING:** There is danger of explosion if the CMOS battery is replaced incorrectly. Disposal of battery into fire or a hot oven, or mechanically crushing or cutting of a battery can result in an explosion.

## 8.6.2 - Précautions et guide d'installation

Ne pas ouvrir ou modifier l'appareil. L'appareil utilise des composants conformes aux réglementations FCC et EC. La modification de l'appareil peut annuler ces certifications.

1. Installez l'appareil en toute sécurité. Manipulez l'appareil avec précaution pour éviter de vous blesser et ne le laissez pas tomber.
2. L'équipement est destiné à être installé dans une zone à accès restreint
3. Pour vous protéger contre une exposition RF excessive, maintenez au moins 20 cm de tout utilisateur et des antennes RF. Utilisez uniquement les antennes double bande fournies avec un gain de 2 dBi/2 dBi.
4. Le dispositif de montage au mur ou au plafond nécessite l'utilisation d'une plaque ou d'un support de montage. La plaque ou le support doit être en métal et avoir une épaisseur minimale de 1 mm.
5. Utilisez des vis à tête plate M4x0,5 mm pour fixer la plaque de montage ou les supports de montage aux trous filetés au bas ou à l'arrière du châssis. Les vis doivent avoir une longueur minimale de 4 mm. Ajoutez 1 mm de longueur de vis pour chaque mm d'épaisseur supplémentaire de plaque ou de support au-delà de 1,5 mm.
6. La température ambiante de fonctionnement doit être comprise entre 0 °C et 45 °C avec une humidité relative sans condensation de 10 à 90 %.
7. L'appareil peut être stocké à des températures comprises entre -10 °C et 85 °C.
8. Gardez l'appareil à l'écart des liquides et des matériaux inflammables.
9. Ne nettoyez pas l'appareil avec des liquides. Le châssis peut être nettoyé avec un chiffon.
10. Laissez au moins 2 pouces d'espace autour de tous les côtés de l'appareil pour un refroidissement correct. Si l'appareil est monté sur une surface verticale, l'orientation recommandée de l'appareil est de sorte que les ailettes du dissipateur thermique permettent à l'air de monter sans obstruction. Des orientations alternatives peuvent entraîner une plage de températures de fonctionnement réduite..
11. Cet appareil est destiné à une utilisation en intérieur uniquement.
12. Utilisez une alimentation externe homologuée UL avec une sortie nominale de 24 à 36 Vdc.

13. Les méthodes de câblage utilisées pour le raccordement de l'équipement à l'alimentation secteur doivent être conformes au Code national de l'électricité, NFPA 70, et au Code canadien de l'électricité, Partie I, CSA C22.1.
14. Prévoyez suffisamment d'espace pour les connexions de câblage du bornier afin que les fils ne se plient pas et soient protégés contre les dommages accidentels.
15. Installez l'appareil uniquement avec des câbles réseau blindés.
16. Utilisez uniquement des câbles approuvés par SAE pour une installation automobile.
17. L'installateur doit avoir de l'expérience dans l'installation du marché secondaire et être familiarisé avec les pratiques générales d'installation d'appareils électroniques dans les véhicules.
18. L'appareil ne doit pas être installé dans le poste de conduite d'un véhicule.
19. L'appareil doit être monté conformément aux pratiques acceptées du marché secondaire et aux matériaux d'installation du véhicule.
20. Utilisez uniquement des connecteurs répertoriés UL pour la connexion aux panneaux de fusibles automobiles.
21. L'appareil radio n'est pas destiné aux services d'urgence.
22. L'entretien et la réparation de l'appareil doivent être effectués par un personnel qualifié. Cela inclut, mais sans s'y limiter, le remplacement de la batterie CMOS. La batterie CMOS de remplacement doit être du même type que celle d'origine.
23. L'élimination appropriée de la batterie CMOS doit être conforme à la gouvernance locale.



**ATTENTION:** Il existe un risque d'explosion si la pile CMOS n'est pas remplacée correctement. L'élimination de la batterie dans le feu ou dans un four chaud, ou l'écrasement ou le découpage mécanique d'une batterie peut entraîner une explosion.