

IGN600

Our Smallest Fanless PC

Ultra-reliable and feature rich, the IGN600 Series combines the ease of x86 architecture with our Hardshell™ Fanless Technology in an Ultra Small Form Factor.

onlogic.com/ign600



Easy To Connect

IGN600 has impressive connectivity for its size, with two USB 3.0 ports, two Gb LAN ports, two mini Display-Ports, and a 3.5mm audio jack on the front.

Sealed, Fanless Design

Hardshell Fanless Technology seals components in a durable, ventless enclosure that cools and protects the system. Measuring at just 34 mm x 115 mm x 82 mm, the IGN600 installs virtually anywhere.

x86 Architecture

The IGN600 makes development easy and integration seamless, thanks to its x86 architecture. Backed by a stable Linux or Windows 10 OS, the IGN600 lets you focus on optimizing your application.

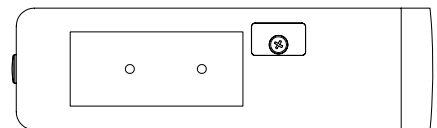
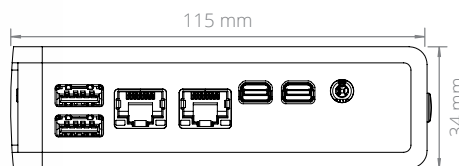

US Office

Phone: +1 802 861 2300 | Email: info@onlogic.com | www.onlogic.com

EU Office

Phone: +31 088 5200 700 | Email: info@onlogic.eu | www.onlogic.com

System	
Processor	Intel Celeron N3350
Processor Speed	1.1 GHz
Processor Cores	2
Integrated Graphics	Intel HD Graphics 500
Memory	LPDDR4 4 GB

Rear I/O	
USB	1 USB 2.0 port
Serial	1 COM Port (RS-232)
Power	1 DC Input Jack (12 V)
Other	Power Button, power indicator LED 1 MicroSD Card slot

Front I/O	
Ethernet	2 USB 3.0 Ports
USB	2 Gb LAN Ports with Realtek RTL8111G
Video	2 Mini-DisplayPort
Other	1 Audio Jack (Mic-in, Line-out)

Side I/O	
Other	4 Antenna jacks

Expansion & Features	
Expansion & Storage	1 PCIe Mini Card (Half-Height) MicroSD Card mSATA (Shared PCIe Mini Card Slot)
Features	32 GB onboard EMMC Storage

Mechanical	
Dimensions (WxHxD)	115 mm x 82 mm x 34 mm
Mounting Options	DIN-mount VESA-mount Wall-mount

Environmental & Regulatory	
Operating Temperature	0°C ~ 40°C
Certifications	2002/96/EC (WEEE Directive) 2011/65/EU (RoHS 2 Directive) Additional Safety and EMC certifications pending CB scheme CE EN 55024 EN 55032 EN 62368-1 FCC 47 CFR Part 15 IEC 62368-1 IP50 UL Listed

US Office

Phone: +1 802 861 2300 | Email: info@onlogic.com | www.onlogic.com

EU Office

Phone: +31 088 5200 700 | Email: info@onlogic.eu | www.onlogic.com

IGN600 Dimensional Drawings

Industrial USFF Edge Device

All measurements in mm

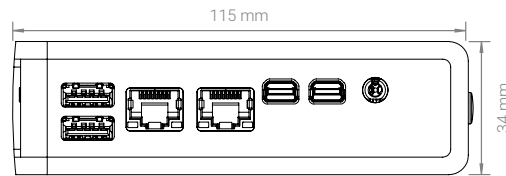

CL210G-10 FRONT

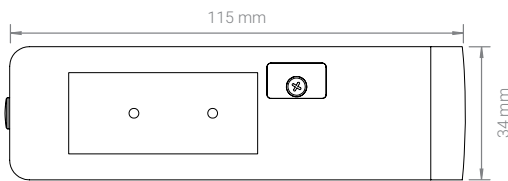

BACK

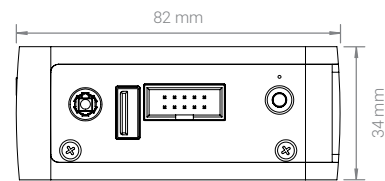

SIDE

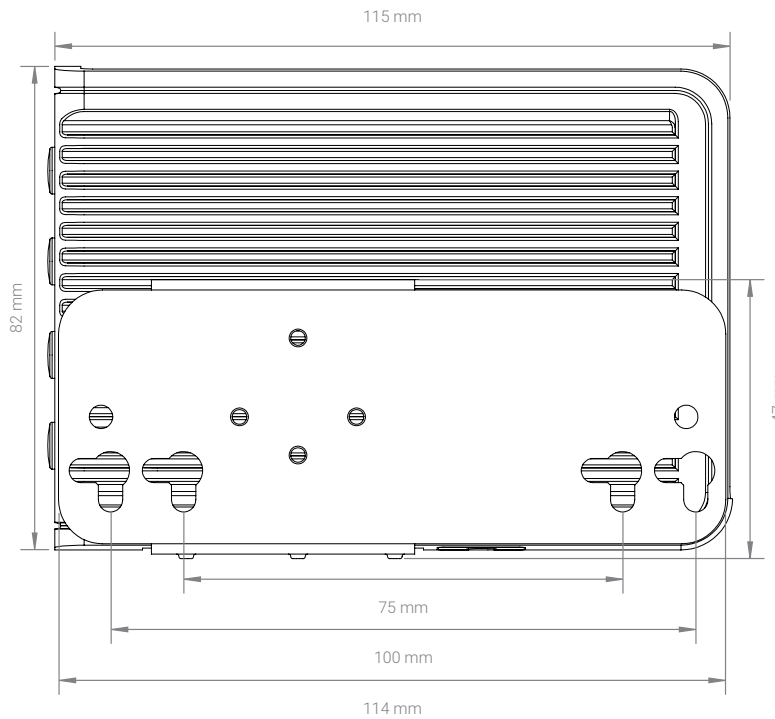

TOP

US Office

Phone: +1 802 861 2300 | Email: info@onlogic.com | www.onlogic.com

EU Office

Phone: +31 088 5200 700 | Email: info@onlogic.eu | www.onlogic.com

EMP162 Dimensional Drawings

All measurements in mm

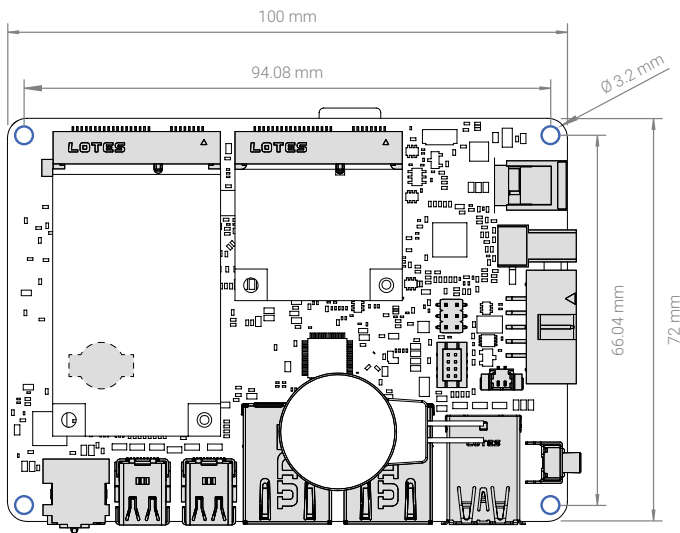

TOP

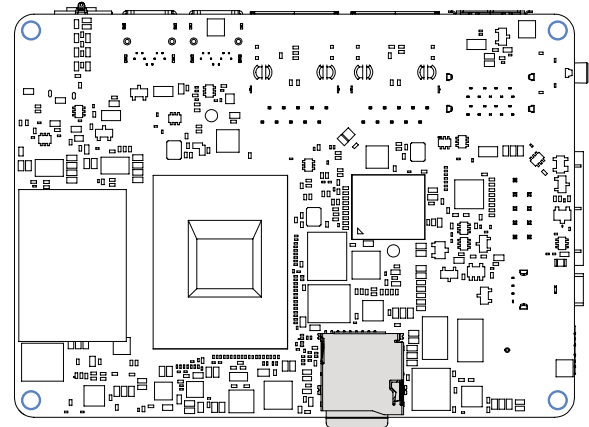

BOTTOM

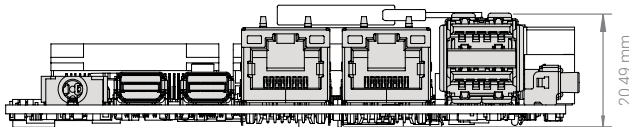

FRONT

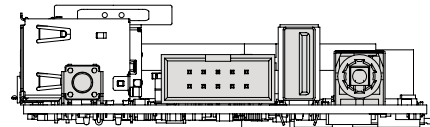

SIDE