



Reliable Fanless Rackmounts.

The MK020 Series of Fanless Rackmount computers brings solid state reliability, and silent, fanless operation to your unique application.

onlogic.com/fanless-rackmounts



Function Meets Form

Designed to enable our fanless systems to be installed in your existing rackmount infrastructure, the MK020 Series lets you choose your ideal hardware solution.

Room to Grow

The unique design of the MK020 Series allows you to install two small form factor fanless systems side by side, enabling high performance, multi-board computing.

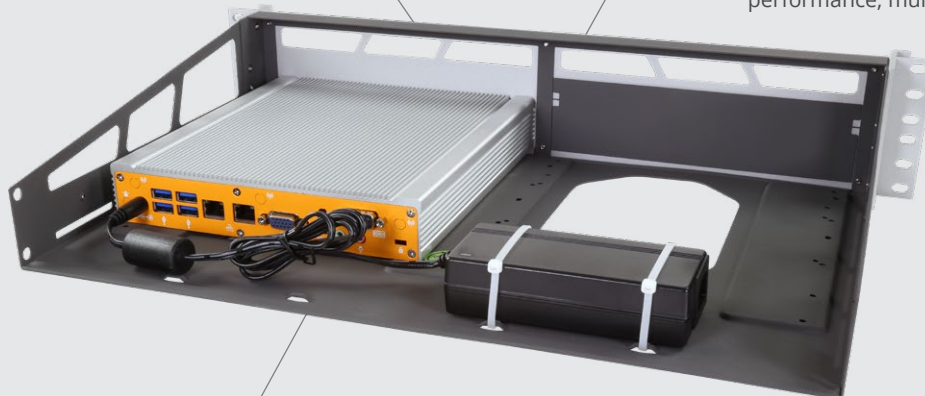

A More Reliable Rackmount

Passively cooled without the use of failure-prone fans, our fanless rackmount systems help ensure long lasting performance and reduce maintenance costs.

US Office

Phone: +1 802 861 2300
Email: info@onlogic.com
www.onlogic.com

EU Office

Phone: +31 088 5200 700
Email: info@onlogic.eu
www.onlogic.com

Fanless Intel® Haswell 2U Rackmount Computer

Specifications

MK020-50

Front I/O	22 USB 2.0 ports Power button	Memory Capacity	Up to 16 GB
Rear I/O	1 HDMI port 1 DisplayPort 1 DVI-I port 4 USB 3.0 ports 2 Gb LAN ports 3 RS-232/422/485 COM ports 2 Audio jacks; line-out, mic-in 1 DC Jack	Memory Speed	1600 MHz
Processor	Intel Celeron, Pentium, Core i3	LAN Controller	Intel I210 GbE Intel I217LM GbE with Intel AMT
Processor Speed	Configuration Dependent	Input Voltage	12 V
Processor Generation	Haswell	Power Input	DC jack
Processor Core	2	Operating Temp. Range	0°C ~ 45°C
Graphics / GPU	Intel HD Graphics	Dimensions (WxHxD)	482.6 mm x 88.9 mm x 288.5 mm
Memory Type	DDR3 SO-DIMM (non-ECC)	Case Material	Steel With Aluminum Extrusion

Dimensional Drawings

All measurements in mm

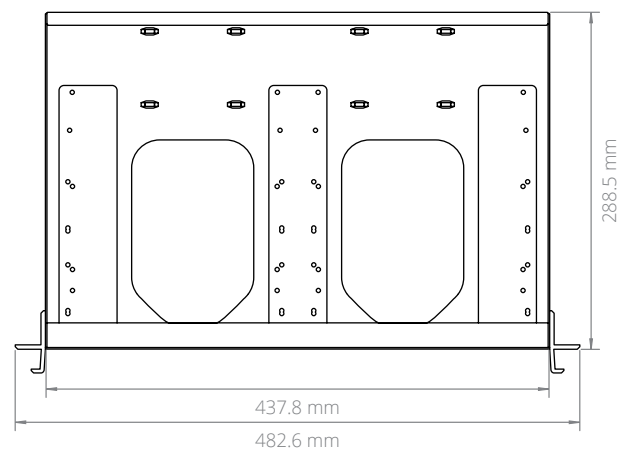

onlogic.com/mk020-50



US Office

Phone: +1 802 861 2300

Email: info@onlogic.com

www.onlogic.com

EU Office

Phone: +31 088 5200 700

Email: info@onlogic.eu

www.onlogic.com

[SKU] Dimensional Drawings

Descriptor

All measurements in mm

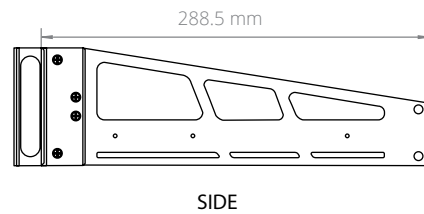
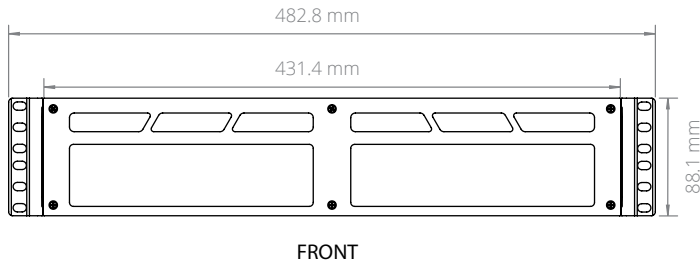

* Two front plate styles accommodate Onlogic fanless chassis*

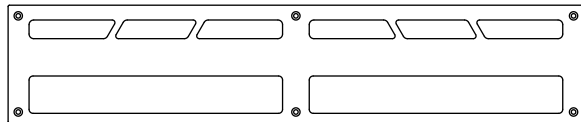

ML210, ML340

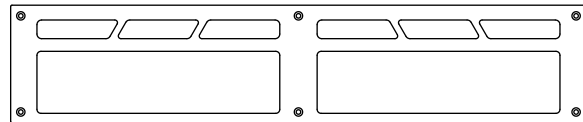

ML400, ML450

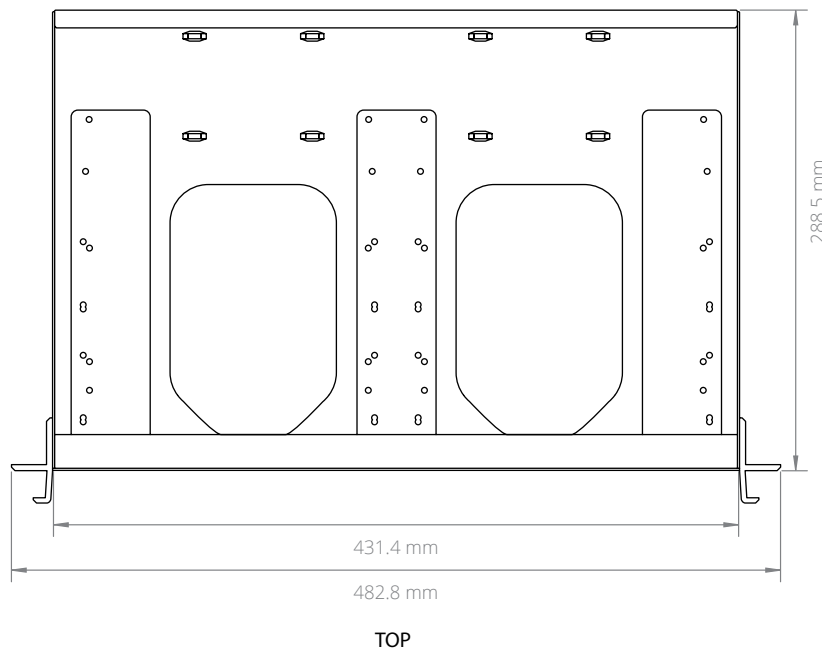

onlogic.com/fanless-rackmounts >

US Office

Phone: +1 802 861 2300
Email: info@onlogic.com
www.onlogic.com

EU Office

Phone: +31 088 5200 700
Email: info@onlogic.eu
www.onlogic.com